

# SafetyGrip® HINGED REAR WALL MOUNT GRAB POLE

SG530

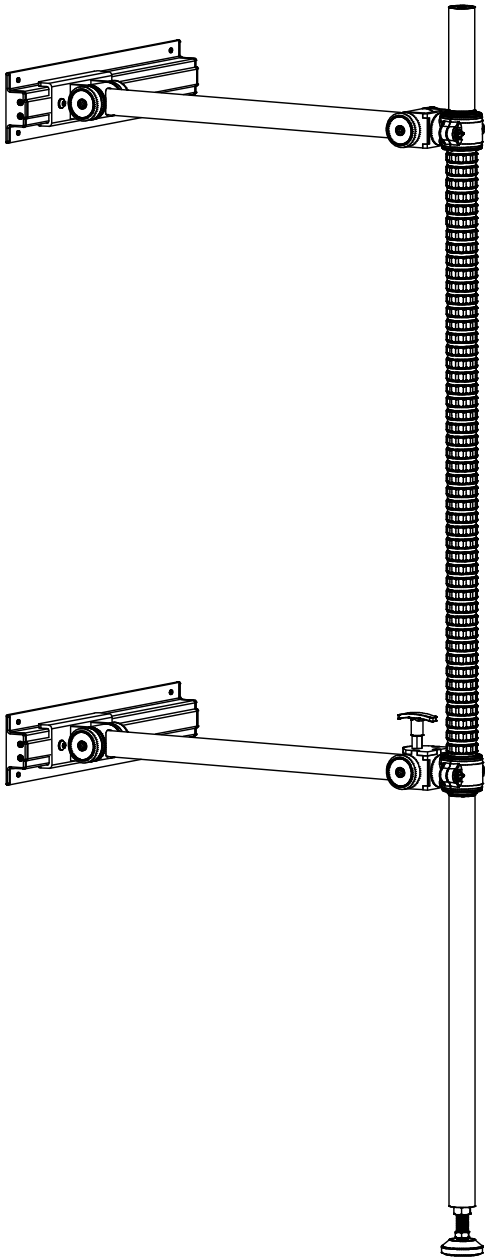

## Specifications:

- Product Name: SafetyGrip® Hinged Rear Wall Mount Grab Pole
- Product#: SG530

## Table of Contents

- Warnings and Cautions for Hercules Grab Poles (2 Pages)
- Entrapment Prevention Information for Poles (2 Pages)
- Additional Warnings and Cautions for Grab Poles used Against a Bed (2 Pages)
- SG530 Installation Instructions (8 Pages)

## KIT CONTENTS

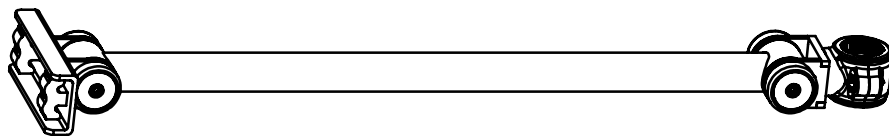

**UPPER HORIZONTAL ARM**

Safety Lock Release

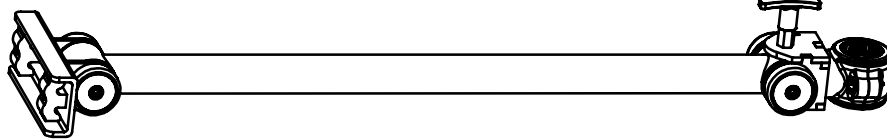

**LOWER HORIZONTAL ARM**

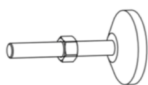

**LEVELLING FOOT**

(Carton 1)



**WALL TRACKS**

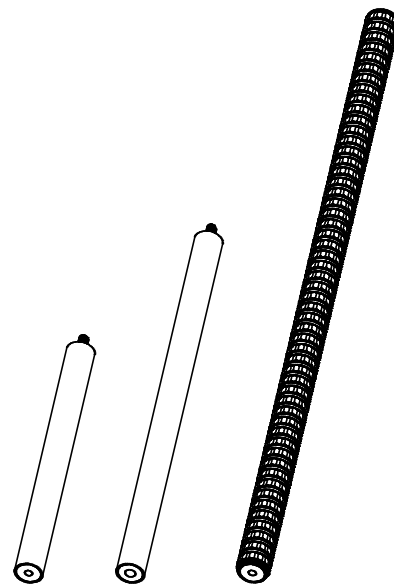

**SafetyGrip POLE**

(Carton 2)

### Tools Included (Carton 1)

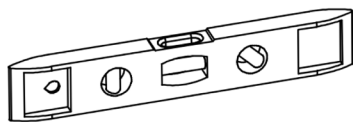

**LEVEL**

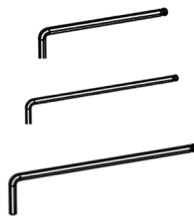

**HEX KEYS**

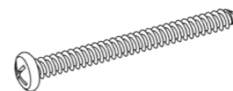

**12-#14 x 3" Woodscrews**

**HARDWARE**



## Tools Required

- Stud Finder
- Safety Glasses
- Power Drill
- Tape Measure
- Masking Tape
- 1/8 inch drill bit for pilot holes for the wood screws
- Philips screw drivers
- Pencil
- Strong scissors or a fine tooth saw

For Installation into metal studs you will need 6 drywall anchor bolts for steel studs not supplied, the necessary drill bit and a tool to tighten the anchor bolts you choose.

## TECHNICAL DATA

Safety and pleasing designs to enhance your general décor, and will increase safety.

- All Hartmobility SafetyGrip® Grab Poles are ADA Compliant and will support up to 350 lbs when installed correctly onto structurally sound walls.
- They feature our patented interlocking SafetyGrip® for the safest available grip.
- They come with the long-lasting protection of embedded antimicrobial AlphaSan® RC5000 silver ions powder for all parts. For more details about AlphaSan®: <https://www.milliken.com/en-us/businesses/chemical/product/alphasan>

**⚠ WARNING: FALL HAZARD.** Attach the grab bar securely to the wall. Failure to do so could result in death or serious injury.

## INSTALLATION

### STEP 1: Remove End Caps & Seal from the Wall Tracks

1. Unscrew the plastic End Caps from the Wall Tracks.
2. Slide out the Wall Track Seal.
3. Put these parts and the screws to one side. You will re-assemble these later.

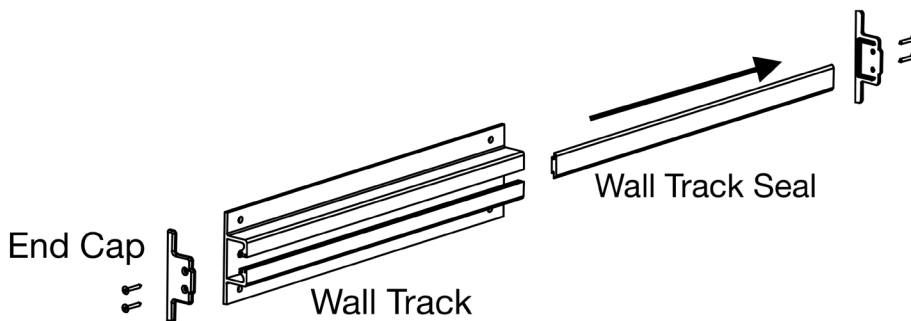

## STEP 2: Mount the Wall Tracks on the wall. 2a for Wood Studs. 2b for Steel Studs

The height of the Wall Tracks can vary according to your installation requirements.

**INSTALLER NOTE** 1 in **Step 2** is very important and must be followed when the pole is against a bed.

### **Note 1:**

**IMPORTANT:** If using this Grab Pole against a bed;

To prevent any possible Entrapment Hazard as described in the Entrapment Prevention Information provided follow A, B & C.

- A. If the Grab Pole will be closer than 12-1/2 inches(318mm) to the side of the bed after installation you will also need the 600120 Pole Retention Strap Kit (Strap). Also included with this Strap are Additional Warnings and Cautions for Bedside Pole and Additional Installation Instructions that must be followed.
- B. The lower Horizontal Arm must be located at a maximum height where the gap under the Horizontal Arm to the top of the mattress is no more than 2 inches (50mm) above the top of the mattress. Alternately the lower Horizontal Arm can be mounted at any height below the top of the mattress to within 8 inches (200mm) of the floor.
- C. If the Grab Pole will be away from the side of the bed more than 12-1/2 inches (318mm) than you will not need this Strap Kit and you can continue with the Steps that follow.

The drywall must be at least ½ inch (12mm) thick. Usually, the studs are placed 16 inches (406.4mm) on center. The Wall Track is predrilled for these centers. If your studs are on centers less than 16 inches you will have to re-drill the Wall Track with 9/32 diameter holes accordingly. If studs are on centers greater than 16", contact customer service for installation assistance.

### **Note 2:**

If your installation is not against a bed we recommend the heights of the Horizontal Arms as shown in the Wall Track Illustrations that follow.

### **Note 3:**

The Wall Tracks have 12 inches of sideways adjustment allowing you to locate the Grab Pole anywhere you wish between the studs. If your Grab Pole location is near the end of the Wall Tracks the Horizontal Arms can be turned either way.

### **2a: Installing the Wall Tracks into wood studs:**

For each Wall Track, locate the stud centers at the desired height and, using a pencil, mark the wall with a line 3" long. Use care here to make sure that the wall tracks are horizontal, parallel to each other and that the ends are in line. You can use the level provided. See illustrations below.

1. Locate the studs that you will be installing on. Use making tape to protect your wall; draw a vertical line in the center of each stud.
2. Measure the height from the floor to the top of each Wall Track, and using masking tape to protect your wall, make a horizontal line.
3. Place the Wall Tracks on the wall with the Track holes on center to the marks that you have made. Use the pencil to clearly mark all the track holes through the Wall Track.
4. Remove the Wall Track from the wall
5. Pre-drill 1/8" diameter holes for the wood screws.
6. Install the Wall Tracks using the 12 - #14 x 3" long wood screws supplied.

Slide the Horizontal Arms onto the Wall Tracks - you can leave them loose at this point.

## 2b: Installing the Wall Tracks into Steel studs

For each Wall Track, locate the stud centers at the desired height and, using a pencil, mark the wall with a line 3" long.

1. Locate the studs that you will be installing on. Use masking tape to protect your wall; draw a vertical line in the center of each stud.
2. Measure the height from the floor to the top of each Wall Track, and using masking tape to protect your wall, make a horizontal line.
3. Place the Wall Tracks on the wall with the Track holes on center to the marks that you have made. Use the pencil to clearly mark all the track holes through the Wall Track.
4. Remove the Wall Track from the wall.
5. Drill the correct size holes for the drywall anchor bolts that you are using
6. Install the Wall Tracks using the 6 drywall anchor bolts that you have chose to use - not supplied.

Slide the Horizontal Arms onto the Wall Tracks - you can leave them loose at this point.

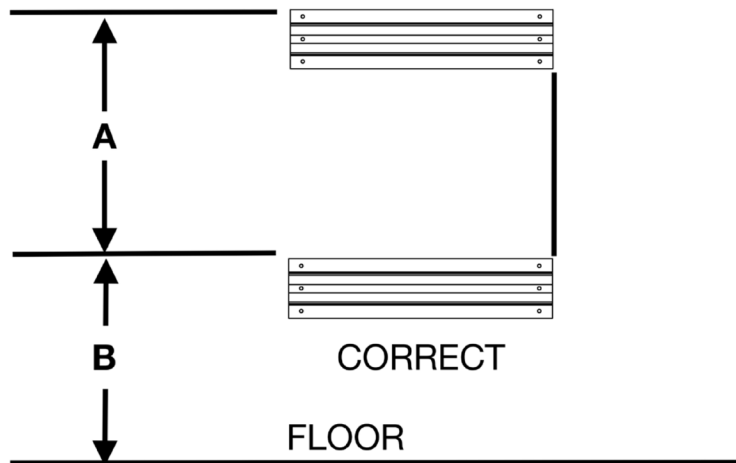

**A:** 30" minimum. 60" maximum

**B:** 8" Minimum. See Note 2 above

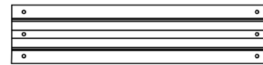

X



NOT PARALLEL

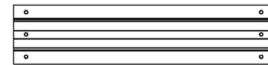

X

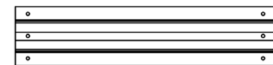

ENDS NOT IN LINE VERTICALLY

### STEP 3: Assemble the Pole

Apply 3 lines of thread locker equally around the screw threads as shown.

Note: Any excess thread locker can be wiped clean

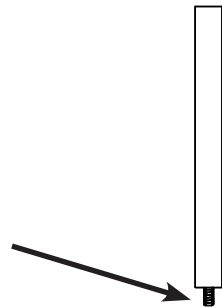

TOP TUBE



MIDDLE TUBE

Apply 3 lines of thread locker equally around the screw threads as shown.

Note: Any excess thread locker can be wiped clean



BOTTOM TUBE

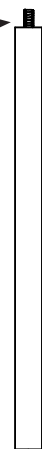

Screw the Levelling Foot into the Bottom Tube

Do not use Thread Locker here



LEVELLING FOOT

## STEP 4: Join the Grab Pole to the Horizontal Arms

1. Remove the screws and nuts from the Grab Pole Clamps on the ends of the Horizontal Arms. Use the Hex Key provided.
2. Stand the Grab Pole against the opened clamp on the Horizontal Arms.
3. Re-assemble the clamp with the screws and nuts, and tighten securely.
4. Now you can tighten the screws that secure the Horizontal Walls tracks.

**Note:** Make sure that your Grab Pole is vertical to the floor.

5. Adjust the Leveling foot until it is firmly on the floor. Tighten the locking nut on the Leveling Foot against the bottom of the Grab Pole.

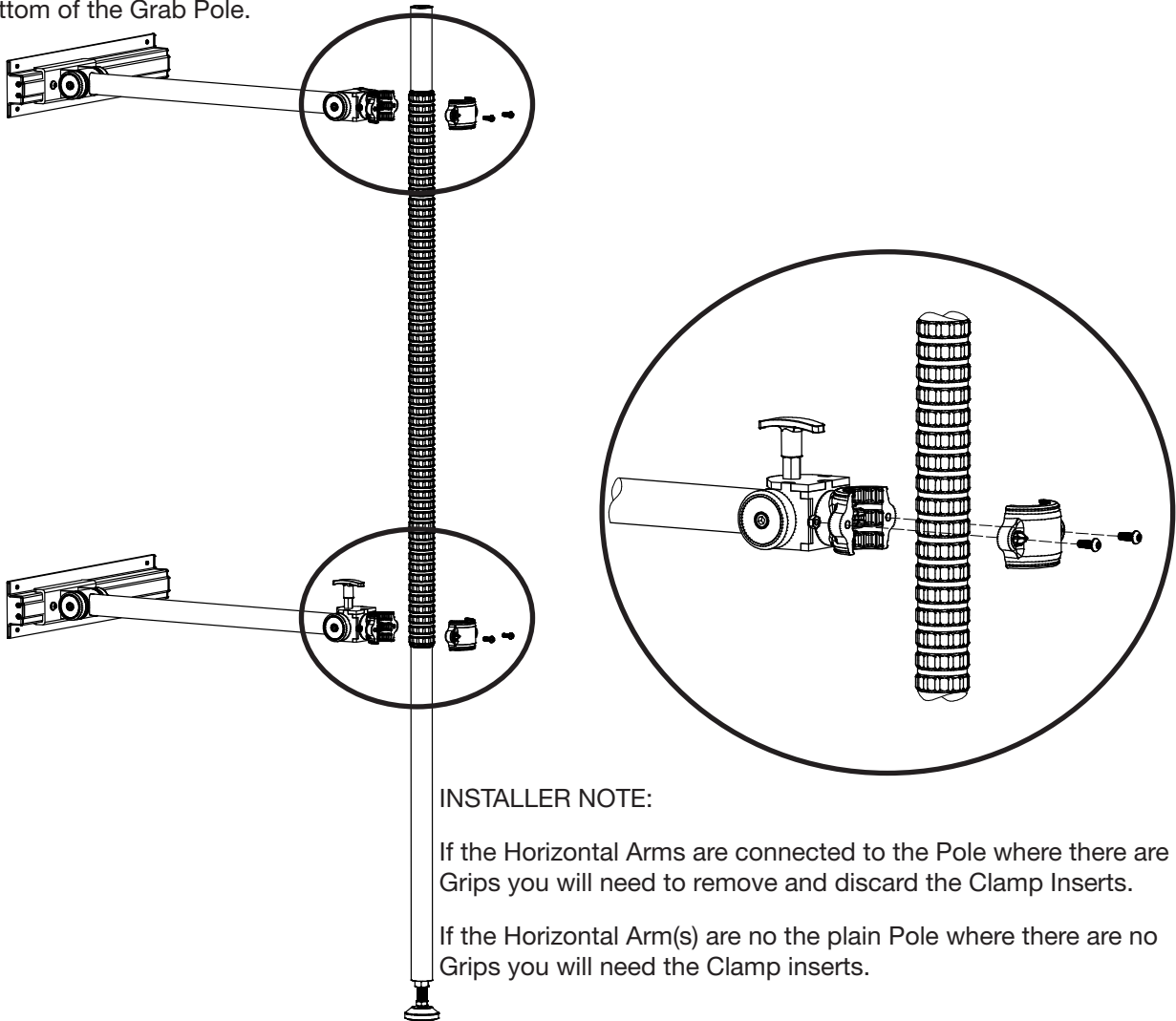

### INSTALLER NOTE:

If the Horizontal Arms are connected to the Pole where there are Grips you will need to remove and discard the Clamp Inserts.

If the Horizontal Arm(s) are no the plain Pole where there are no Grips you will need the Clamp inserts.

## STEP 5: Re-Assemble the Wall Track seal and End Caps

1. First slide the seal into one end of the Wall Track and mark the end level with the end of the Wall Track.
2. Cut the Seal to length. Strong scissors or a small saw can do this.
3. Repeat Steps 1 & 2 until the Wall Track has all the Seals inserted.
4. Screw the Wall Track plastic End Caps into the ends of the Wall Tracks.
5. Your Wall Tracks are now fully sealed.

## STEP 6: Final Checks

Make sure that all nuts, bolts and screws are securely tightened.

## INFORMATION

The Model SG605 Exercise Clamp Accessory and SG515 Accessory etc. can be used and it is compatible with all styles of Resistance Bands and Resistance Tubing products.

## MAINTENANCE AND CLEANING

**VERY IMPORTANT:** It is important to inspect the Product(s) frequently.

- Stop using immediately if damaged or broken, or if parts are missing.
- Stop using immediately if Product(s) shift out of the original installed position(s) until they are readjusted into the correct position.
- To clean, use a damp cloth with soap and water or mild household cleaner, wipe clean and dry before using.



Hartmobility reserves the right to update and revise our products. Refer to our website for the most up-to-date version of this document.

Copyright © 2025 Hartmobility Inc. All Rights Reserved.

